



PUBALI BANK LIMITED

CARD DIVISION

A-A Bhaban (2nd floor), 23 Motijheel C/A, Dhaka.
Phone: 02-9512035, 02-9512061(Ext-119,158)

PBL/HO/CARD DIV./ TENDER/ 1349(A)/2020

16 August 2020

NOTICE INVITING QUOTATION FOR DECORATION AND BRANDING WORK AT ATM BOOTH OF OUR BANK.

Sealed quotations are hereby invited from the eligible tenderers for decoration and branding work at ATM booth of our Bank as per our specifications, terms and conditions:

Necessary Layout, Item descriptions and specifications enclosed herewith for a standard ATM Booth size (L=12 feet x W=8 feet X H= 9 feet).

Terms and conditions:-

1. The offer must be submitted through " Schedule " enclosed herewith.
2. **Bidder must have minimum 3 (three) years experience in the relevant work.**
3. The decoration and branding work of our ATM Booth across the country to be completed on case to case basis within 01 (one) year period as per design approved by our Bank.
4. Payment of the bill will be made through Card Division, Head Office, after completion of the works depending on the actual measurement by our engineer with recommendation of the concerned branch and also fulfill all other terms & conditions of the Supply Order.
5. **VAT deduction:** According to the nature of the work, it will be treated under service code "S.050.10 – Architect, Interior Designer or Interior Decorator" and 15% VAT deduction will be made at source at the time of payment.
6. **Income Tax deduction:** Subject to clause (b), in case of a payment made sub-section (1) of section 52 of Income Tax Ordinance 1984 and section 16 of Income Tax Rules 1984 the deduction on payment shall be followed.
7. The above rate and rules of VAT and Tax will be followed until any changes done by the government. In case of any changes by government, VAT & TAX will be **deducted** from the bill as per government rule prior payment of the same.
8. **An earnest money of 10% of the bid value** to be submitted along with the financial offer.
9. In case of successful bidder, the earnest money shall be retained as security money/performance security for 01 year.
10. The supplier has to provide minimum 6 (six) months free maintenance/replace/repair service after handing over the work of each ATM Booth of the bank. In case of electrical/electronic related equipment, minimum 01 year warranty will be provided.
11. 10% of contractor bill shall be retained as security money for a period of 6 months after handing over of the work of each ATM Booth.
12. The authority reserves the right either to accept or to reject all or any offer without assigning any reason.
13. Bank is not bound to accept the lowest Quotation. To be successful in the bid, quality of the offered items, financial capability and reputation etc. of the tenderer as assessed by the Bank are the prime factors for consideration.

14. Photocopy of Trade License, TIN Certificate (e-TIN), VAT registration Certificate (e-BIN), Financial Solvency Certificate, Major client List, **Work experience at ATM Booth** and Company profile to be submitted with the Quotation.

Offer / Bid to be dropped in the Tender Box kept in **Establishment Division, Pubali Bank Limited, Head Office**, 12th Floor, 26 Dilkusha C/A, Dhaka by **11.00 a.m.** up to **26-08-2020** which will be opened on the same day at **11.30 a.m.** in presence of the bidders present (if any).

KA Masud
16/08/20
(Khaled Al Masud)
Senior Principal Officer

(Ashim Kumar Roy)
DGM & Division Head

PUBALI BANK LIMITED
CARD DIVISION
HEAD OFFICE, DHAKA

Schedule for Decoration & Branding works of new ATM Booth at different location
(Rates are inclusive all VAT, IT, material cost, Carrying expenses etc.)

Summary

1 Civil Work	= Tk.	-
2 Electrical Work	= Tk.	-
Total	= Tk.	-

[Taka in word:]

Signature & Seal of Contractor



PUBALI BANK LIMITED
CARD DIVISION
HEAD OFFICE, DHAKA

Schedule of following Decoration & Branding (Civil) work of new ATM Booth at different location (Rates are inclusive all VAT, IT, material cost, carrying expenses etc).

Sl No	Description of Items	Quantity	Unit	Rate(Tk)/ Unit	Amount(Tk)
1	Homogenous Floor/Stair tiles(Size:12"x12") : Supplying, fitting and fixing of 12"x12" homogenous floor/stair tiles(RAK/Fu-wang/as per approved sample by Architect/RM/BM) at floor by 25 mm thick cement mortar(1:3) ratio after removing the existing plaster and racking out the joint with tiles/granite grout including colored pigment, cutting and laying tiles in proper way and finishing with care etc. all complete as per drawing/design and also direction of Architect/BM/RM. (Only covered area will be considered for measurement.)	144.00	sft	-	-
2	Aluminium Composite Panel (As per approved sample) : Supplying, fitting & fixing of Aluminium composite panel with 1" x 1" MS box including proper finishing (As per Approved sample, colour: Green & Yellow) at walls & canopy as per drawing, design in/c all accessories etc. all complete as per drawing/design and also direction of Architect/BM/RM. (Only covered area will be considered for measurement.)	523.00	sft	-	-
3	Aluminium Profile Box signage : Supply and installation of Panaflex (Reverse Print & Aluminium Profile Box signage, size: 5' x 3', 5' x 4' & 12' x 3') as per our Bank's standard according to drawing/design. Sign Board's base to be made by imported Aluminium Profile and the Signboard will be fitted/hanged strongly by 1.5" x 1.5" Iron angle frame, rowel bolts etc. with outside wall/ceiling/ACP as convenient position. The width of all letters should be done proportionately as per Bank's standard(Provide one row light per ft). Specification : Profile Box: Aluminium, Print : Reverse, Print Ink Jar: LG Korean Panaflex Sheet: Panaflex sheet must be 666GSM with impact resistant Penaflex sheet with UV protection on both sides. Preferable origin to be USA or UK. Ballast: Australia (ATCO) Original/Racer (Thailand) Tube light: Eastern/C-Taiwan at 1'-0" interval, 40 watt tube light. Switch: Separate switch for each row of tube light. Internal wiring Cable: Individual light wiring to be done by 1x3/0.29 IYAL single core eastern cable (original) phase+neutral wiring for each row to be done by 1x7/0.29 IYAL eastern cable (original), the body of signboard to be properly earthed by 1x7/0.029 green colour IYAL eastern cable (original)(ECC) each row of light wiring to be terminated to the separate circuit breaker 10A SP MCB. Starter: Philips 40watt. In case of LED tube light, it is noted that required number of 18 watt LED tube light with renowned brand will be placed instead of the above mentioned tube light (sample of light will be approved by the Bank).	91.00	Sft	-	-



(Seal and Signature of contractor)

4	Colour Inject Sticker with different pictures/ photos : Supplying, cutting & pasting of best quality Colour Inject Sticker with different pictures/photos (Approved) on aluminium composite panel of canopy, etc. all complete as per drawing/design and also direction of Architect/BM/RM. (Only covered area will be considered for measurement.)	168.00	sft	-	-
5	Frosted Paper : Supplying, cutting & pasting of best quality frosted paper (Approved) on all glass partition including all accessories etc. all complete as per drawing/design and also direction of Architect/BM/RM. (Only covered area will be considered for measurement.)	168.00	sft	-	-
6	Tempered Glass Swing Door : Supply and installation of 10 mm thick tempered glass swing door at Main entry(Size : 3'-0" x 7'-0") using all necessary accessories etc. all complete as per drawing/design and also direction of Architect/BM/RM.	21.00	sft	-	-
7	Non tempered Glass Partition: Supplying, fitting & fixing of 10 mm thick non tempered glass partition upto 7'-0" height using aluminum protector bit/ U-channel & other all necessary accessories etc. all complete as per drawing/design and also direction of Architect/BM/RM.	35.00	sft	-	-
8	Metal False Ceiling : Supplying, fitting & fixing of metal board (as per approved sample) with a milk white PVC membrane with powder coated T bar frame, 2'-0" x 2'-0" sized metal board(approved color) in grid suspended from ceiling by 16 swg double ply GI wire fixed in the ceiling by rowel plug, screens, hooks, nails etc. maintaining straight lines and desired finished level including making holes in slabs or beams by electric drill and mending good the damages if any execution of work including cost of all materials accessories scaffolding labour for installations screws, nails in/c/ provision for fitting led panel light sets properly in false ceiling etc. all complete as per drawing/design and also direction of Architect/BM/RM. (Light Shed area and column area will be deducted in the measurement)	96.00	sft	-	-
9	Road side signage : Supply and installation of round shape both side signage, 18" dia. Sign Board's base to be made by 2mm opel color acrylic sheet and 0.6mm SS sheet and the signboard will be hanged strongly by 3/4" SS pipe, ss rowel bolts etc. with outside wall/ceiling/ACP/ as convenient position. Print: clear sticker. light: Eastern/Transtec/Super Star, round tube light (2 sets 23/32 watt/as per required) or required LED strip light with controller with renowned brand as approved by the Bank.	1.00	pcs.	-	-
10	Melamine Board Cabinet): Supplying, fitting & fixing of cabinet to be made by 3/4" thick melamine Board cabinet (Size: 2'-6" x 2'-6" x 3'-2.5") with necessary locking system in/c best quality paint/polishing, Arm strong lock, metal handle nob for each single cabinet etc. Here, some hole will be at the backside of cabinet for passing wire from inside to outside(like power cable). All complete as per drawing/ design and also direction of Architect/BM/RM.(Only front elevation will be considered in measurement)	8.12	sft	0	-



11	Plastic Emulsion Paint : Supplying & applying of Plastic emulsion Paint of approved (Berger) Colour (As per approved sample) delivered from authorized local agent of the manufacturer in a sealed container to wall/ceiling two coats over a coats of Damp proof course & Ready-mix putty (Brand-Berger) elapsing specified time for drying/re-coating including cleaning drying, making free from dirt, grease, wax, removing all chalked & sealed materials, fungus, mending good the surface defects, sand papering the surface and necessary scaffolding, spreading by brush/roller etc. all complete as per drawing/design and also direction of Architect/BM/RM.	1,304.00	Sft	0.00	-
12	Synthetic Enamel Paint : Supplying & applying of Synthetic Enamel Paint of approved (Berger) Colour (As per approved sample) delivered from authorized local agent of the manufacturer in a sealed container to both side of Shutter/Collapsible Gate two coats over a coats of anti rust red oxide elapsing specified time for drying/re-coating including cleaning drying, making free from dirt, grease, wax, removing all chalked & sealed materials, fungus, mending good the surface defects, sand papering the surface and necessary scaffolding, spreading by brush etc. all complete as per drawing/design and also direction of Architect/BM/RM.	200.00	Sft	0.00	-
13	Weather Coat: Supplying of weather coat, Brand: Burger, Colour (As per approved sample) & applying to outside wall, two coats over a coat of brand specified putty (Brand: Burger) including cleaning and sand papering the surfaces and necessary scaffolding etc. all complete as per drawing/design and also direction of Architect/BM/RM.	500.00	Sft	-	-
14	PVC Board along with sticker: Supplying, fitting & fixing of PVC Board (Thickness: 4.75 mm, Brand: Partex/RFL) on the interior wall by SS screws, royl plug & then supplying, cutting & pesting of sticker (As per approved sample) on the PVC Board including cleaning and sand papering the surfaces and necessary scaffolding etc. all complete as per drawing/design and also direction of Architect/BM/RM.	200.00	Sft	-	-
15	Dismantling Works: Dismantling of the floor tiles/brick wall which will not use and removing the debris to the safe distance etc. all complete as per drawing/design and also direction of Architect/BM/RM.	50.00	Sft	-	-
16	Roller Shutter (Size: 9'-8" x 8'-6"): Supplying, fitting & fixing of Roller shutter to be made by 18 gague M.S Sheet (As per approved sample) along with frame, fittings & enamel paint of two coated over a coat of primer. Both the side guides (thickness 6 mm). The top cover of shaft, spring etc. should be of the same materials as that of lath. Hood, brackets etc. are required to cover the shaft etc. Shutter channel will be concealed in wall & floor etc. all complete as per drawing/design and also direction of Architect/BM/RM.	82.50	sft	-	-

K.A. Mondal



PUBALI BANK LIMITED
CARD DIVISION
HEAD OFFICE, DHAKA

Schedule of following Decoration & Branding (Electrical) work of new ATM Booth at different location (Rates are inclusive all VAT, IT, material cost,

Item No	Description of Item	Quantity	Unit	Rate in Tk	Amount in Tk
01	1C-2 x 1.5 sq.mm PVC insulated cable (BYA, rm) cable (for LED/ Profile box light connection) manufactured by BRB/ Paradise /Poly/ Supersign or equivalent approved by the Engineer-in-Charge.	328	Rft	-	-
02	Providing & fixing of Concealed type 12 Watt LED down Light fitting of following model, consisting of min. 150 mm dia (Round shape) & 25.4mm height body & arms with Powder coated Paint, SMD type Chips, 6000K color temperature, Electronic LED driver, connector, necessary wiring with 2 x 0.4 Sq. mm. Stranded PVC insulated flexible FR Cable etc. all Complete (Including LED Lamp) as per sample approved by the Engineer / Architect. Similar to Gloria lighting model : GDLR 101 or equivalent approved by the Engineer / Architect.	6	Set	-	-
Total Tk.=					-

[Handwritten Signature]

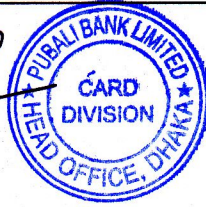

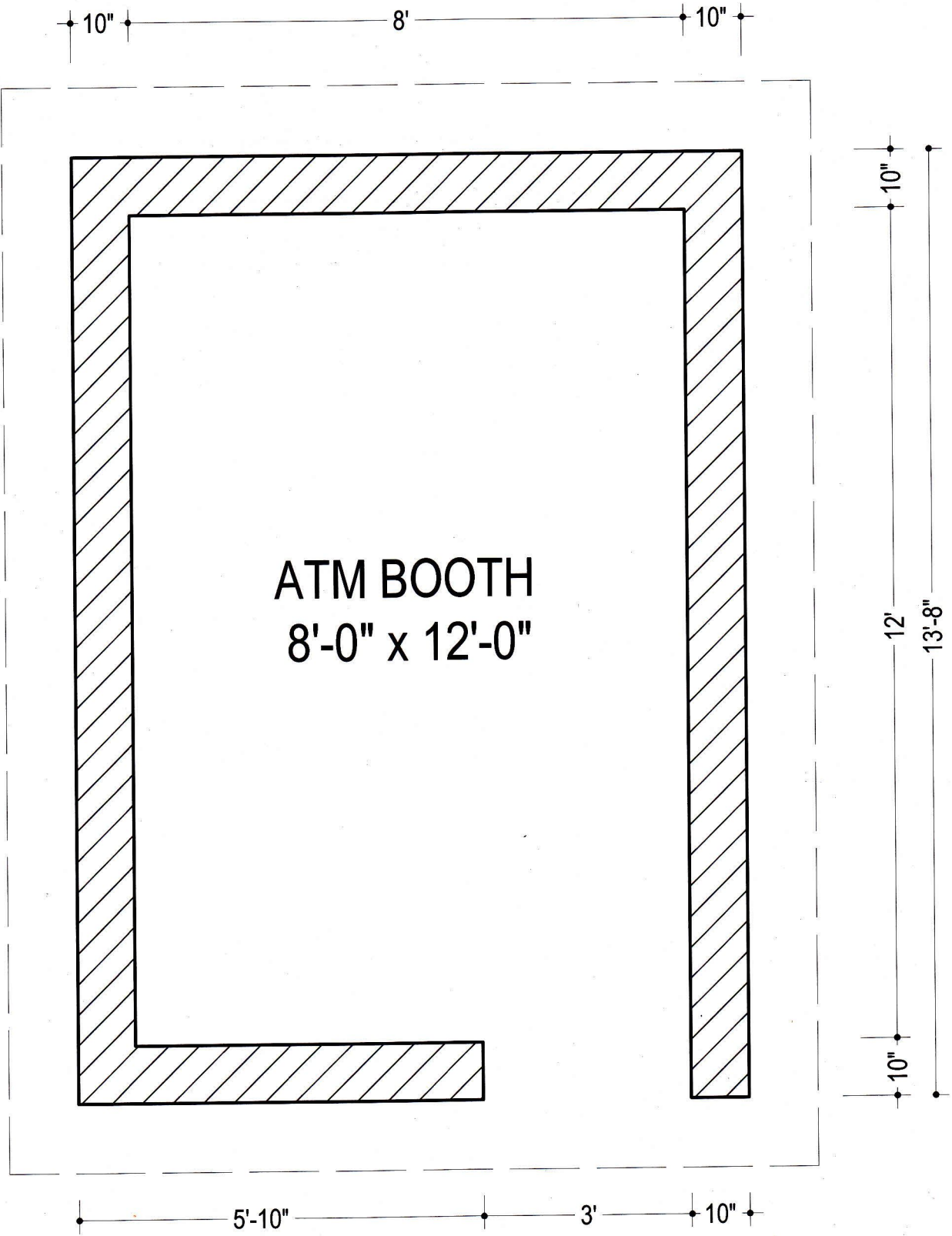

ATM BOOTH
8'-0" x 12'-0"

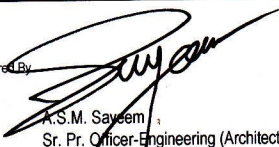

ATM BOOTHS LAYOUT FOR INTERIOR & BRANDING ON CASE TO CASE BASIS.
FOR OUR CARD DIVISION, PUBALI BANK LIMITED, HEAD OFFICE, DHAKA.
A-A BHABAN, 23, MOTIJHEEL COMMERCIAL AREA, 2ND FLOOR, DHAKA.

Proposed Layout & Other Design Prepared By  A.S.M. Saysem Sr. Pr. Officer-Engineering (Architect) Pubali Bank Limited GS & DD, H.O Dhaka-1000.	Description of Design/Layout Floor Layout.	Date of Design/Layout	Sheet No. of Design/Layout
		25/01/2017	01 (One)

পূবালী ব্যাংক লিমিটেড
সাধারণ সেবা ও উন্নয়ন বিভাগ
প্রধান কার্যালয়, ঢাকা।

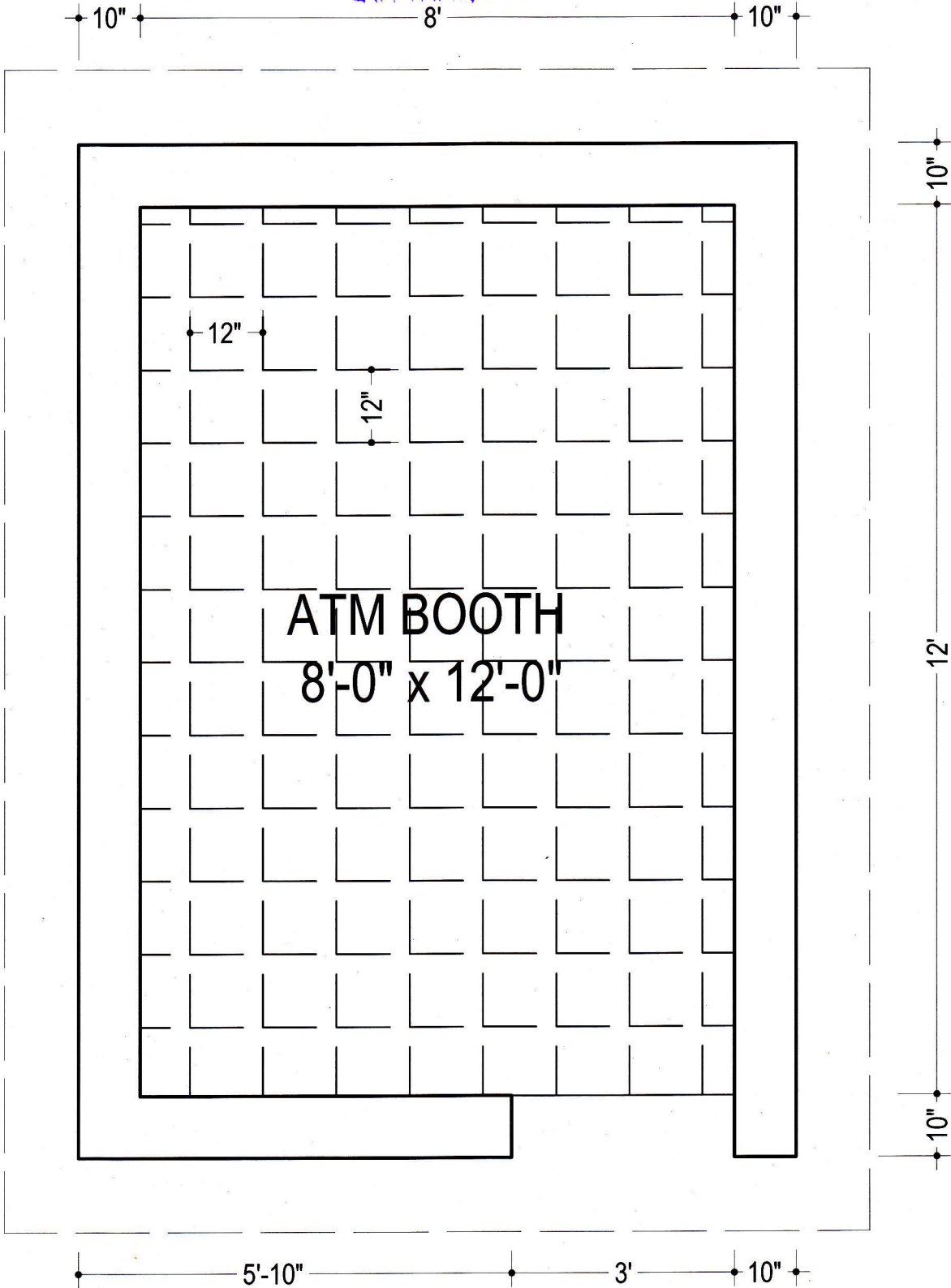

ATM BOOTHS LAYOUT FOR INTERIOR & BRANDING ON CASE TO CASE BASIS.
FOR OUR CARD DIVISION, PUBALI BANK LIMITED, HEAD OFFICE, DHAKA.
A-A BHABAN, 23, MOTIJHEEL COMMERCIAL AREA, 2ND FLOOR, DHAKA.

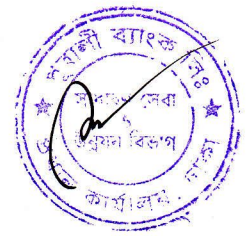

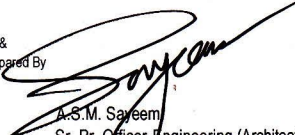
Proposed Layout & Other Design Prepared By  A.S.M. Sayeem Sr. Pr. Officer-Engineering (Architect) Pubali Bank Limited GS & DD, H.O Dhaka-1000.	Description of Design/Layout Floor Tiles Layout.	Date of Design/Layout 25/01/2017	Sheet No. of Design/Layout 02 (Two)

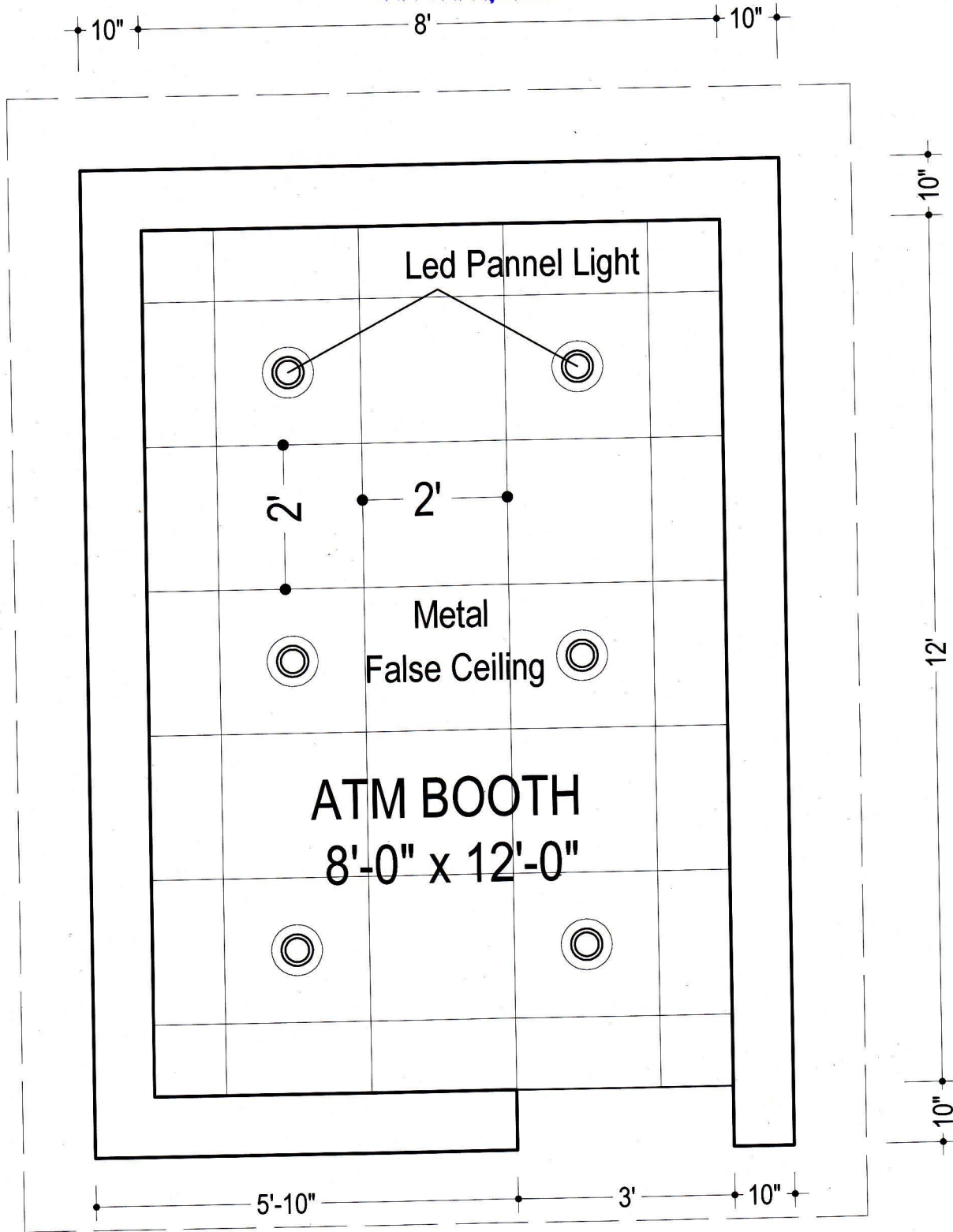

ATM BOOTHS LAYOUT FOR INTERIOR & BRANDING ON CASE TO CASE BASIS.
FOR OUR CARD DIVISION, PUBALI BANK LIMITED, HEAD OFFICE, DHAKA.
A-A BHABAN, 23, MOTIJHEEL COMMERCIAL AREA, 2ND FLOOR, DHAKA.

Proposed Layout &
Other Design Prepared By

(Signature)
A.S.M. Sayeem
Sr. Pr. Officer Engineering (Architect)
Pubali Bank Limited
GS & DD, H.O
Dhaka-1000.

Description of Design/Layout

Metal False Ceiling Layout with
LED panel light arrangement

Date of Design/Layout

25/01/2017

Sheet No. of Design/Layout

03 (Three)



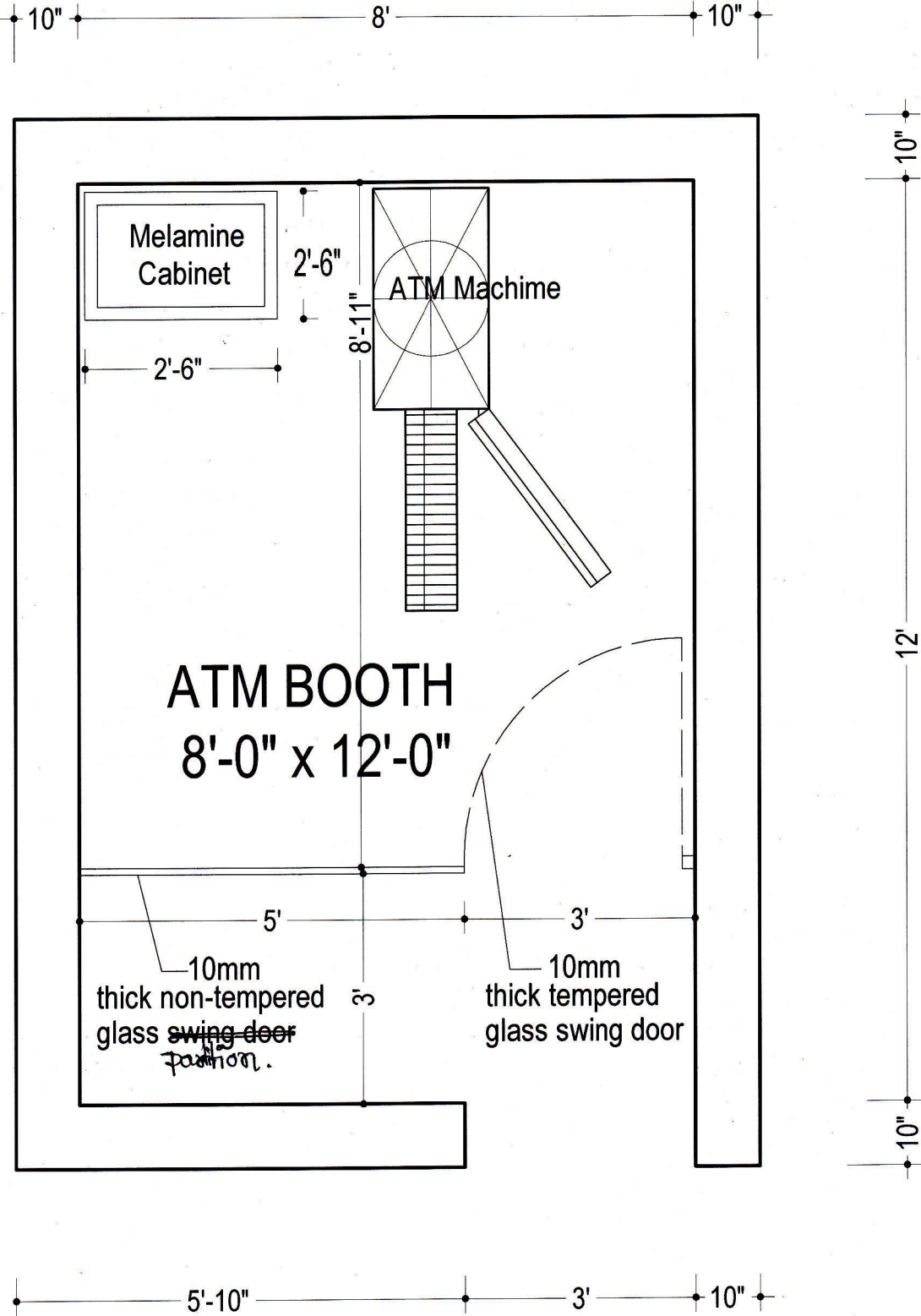

ATM BOOTHS LAYOUT FOR INTERIOR & BRANDING ON CASE TO CASE BASIS.
FOR OUR CARD DIVISION, PUBALI BANK LIMITED, HEAD OFFICE, DHAKA.
A-A BHABAN, 23, MOTIJHEEL COMMERCIAL AREA, 2ND FLOOR, DHAKA.

Proposed Layout &
Other Design Prepared By

S.M. Sayem
S.M. Sayem
Sr. Pr. Officer, Engineering (Architect)
Pubali Bank Limited
GS & DD, H.O
Dhaka-1000.

Description of Design/Layout

Internal Furniture Layout.

Date of Design/Layout

25/01/2017

Sheet No. of Design/Layout

04 (Four)



পূবালী ব্যাংক লিমিটেড
সাধারণ সেবা ও উন্নয়ন বিভাগ
প্রধান কার্যালয়, ঢাকা।

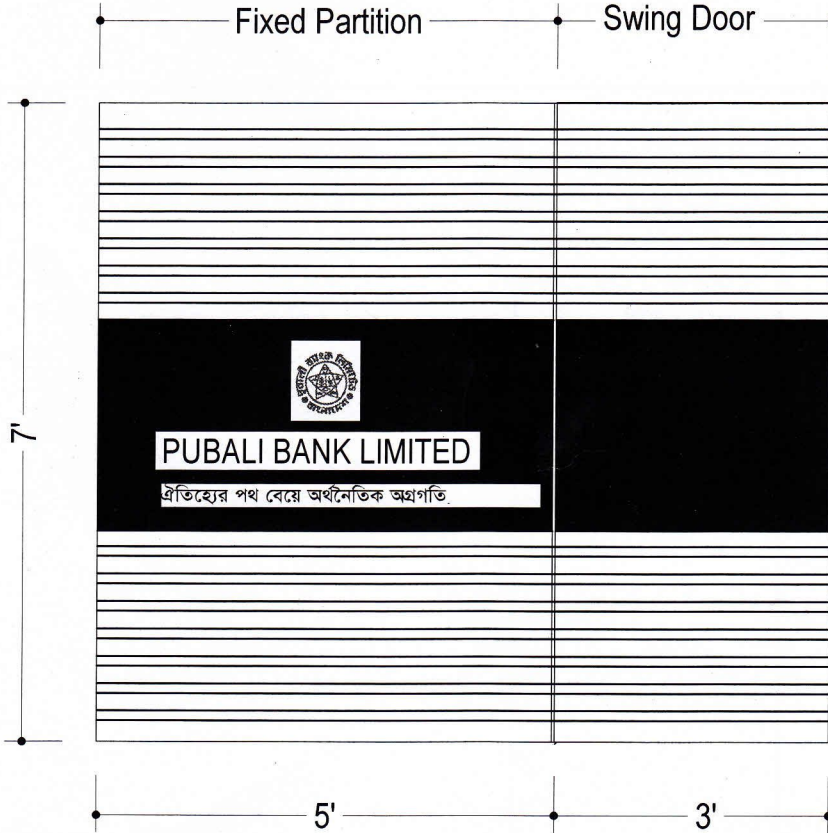

ELEVATION OF TEMPERED SWING DOOR & NON-TEMPERED GLASS PARTITION.

ATM BOOTHS LAYOUT FOR INTERIOR & BRANDING ON CASE TO CASE BASIS.
FOR OUR CARD DIVISION, PUBALI BANK LIMITED, HEAD OFFICE, DHAKA.
A-A BHABAN, 23, MOTIJHEEL COMMERCIAL AREA, 2ND FLOOR, DHAKA.



Proposed Layout &
Other Design Prepared By

A.S.M. Sayeen
A.S.M. Sayeen
Sr. Pr. Officer/Engineering (Architect)
Pubali Bank Limited
GS & DD, H.O
Dhaka-1000.

Description of Design/Layout

Elevation Of Internal 10mm thick Tempered
Glass Swing Door & 10mm thick
Non-Tempered Glass Partition with
Frosted/Coloured Inkjet Sticker Print Design.

Date of Design/Layout

25/01/2017

Sheet No. of Design/Layout

05 (Five)

পূবালী ব্যাংক লিমিটেড
সাধারণ সেবা ও উন্নয়ন বিভাগ
প্রধান কার্যালয়, ঢাকা।

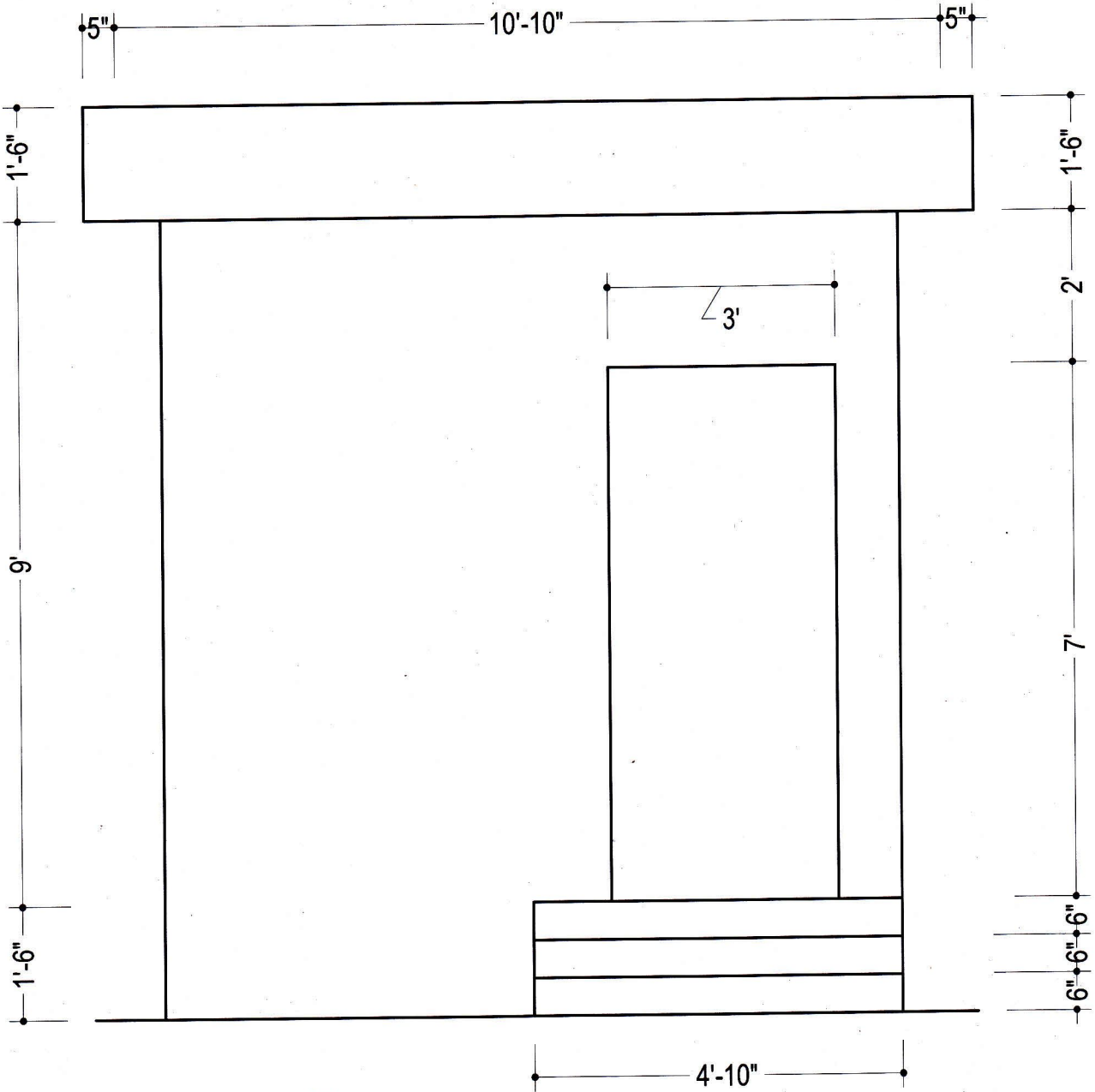

ELEVATION.

ATM BOOTHS LAYOUT FOR INTERIOR & BRANDING ON CASE TO CASE BASIS.
FOR OUR CARD DIVISION, PUBALI BANK LIMITED, HEAD OFFICE, DHAKA.
A-A BHABAN, 23, MOTIJHEEL COMMERCIAL AREA, 2ND FLOOR, DHAKA.



Proposed Layout &
Other Design Prepared By

A.S.M. Sayeem
A.S.M. Sayeem
Sr. Pr. Officer-Engineering (Architect)
Pubali Bank Limited
GS & DD, H.O
Dhaka-1000.

Description of Design/Layout

Front Elevation (without ACp).

Date of Design/Layout

25/01/2017

Sheet No. of Design/Layout

06 (Six)

পুবালী ব্যাংক লিমিটেড
সাধারণ সেবা ও উন্নয়ন বিভাগ
প্রধান কার্যালয়, ঢাকা।

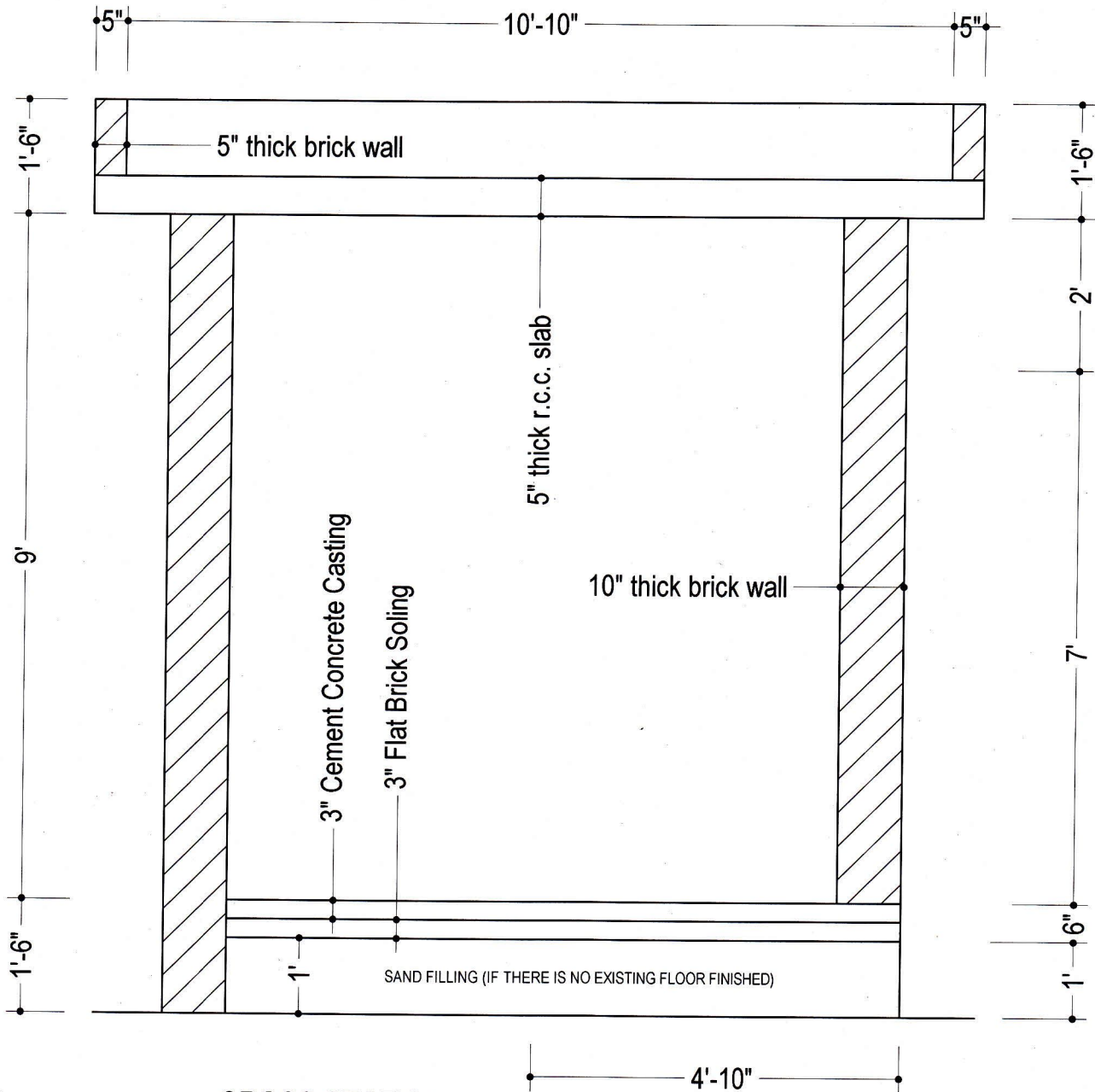

CROSS SECTION

5" & 10" thick brick wall works with necessary plaster & slab (R.C.C) works will be completed by the local authority (i.e. concerned Manager's & R.M.)



ATM BOOTHS LAYOUT FOR INTERIOR & BRANDING ON CASE TO CASE BASIS.
FOR OUR CARD DIVISION, PUBALI BANK LIMITED, HEAD OFFICE, DHAKA.
A-A BHABAN, 23, MOTIJEEL COMMERCIAL AREA, 2ND FLOOR, DHAKA.

Proposed Layout &
Other Design Prepared By

A.C.M. Sayeem
A.C.M. Sayeem
Sr. Pr. Officer-Engineering (Architect)
Pubali Bank Limited
GS & DD, H.O
Dhaka-1000.

Description of Design/Layout

Inside Cross Section.

Date of Design/Layout

25/01/2017

Sheet No. of Design/Layout

07 (Seven)

পুবালী ব্যাংক লিমিটেড
সাধারণ সেবা ও উন্নয়ন বিভাগ
প্রধান কার্যালয়, ঢাকা।

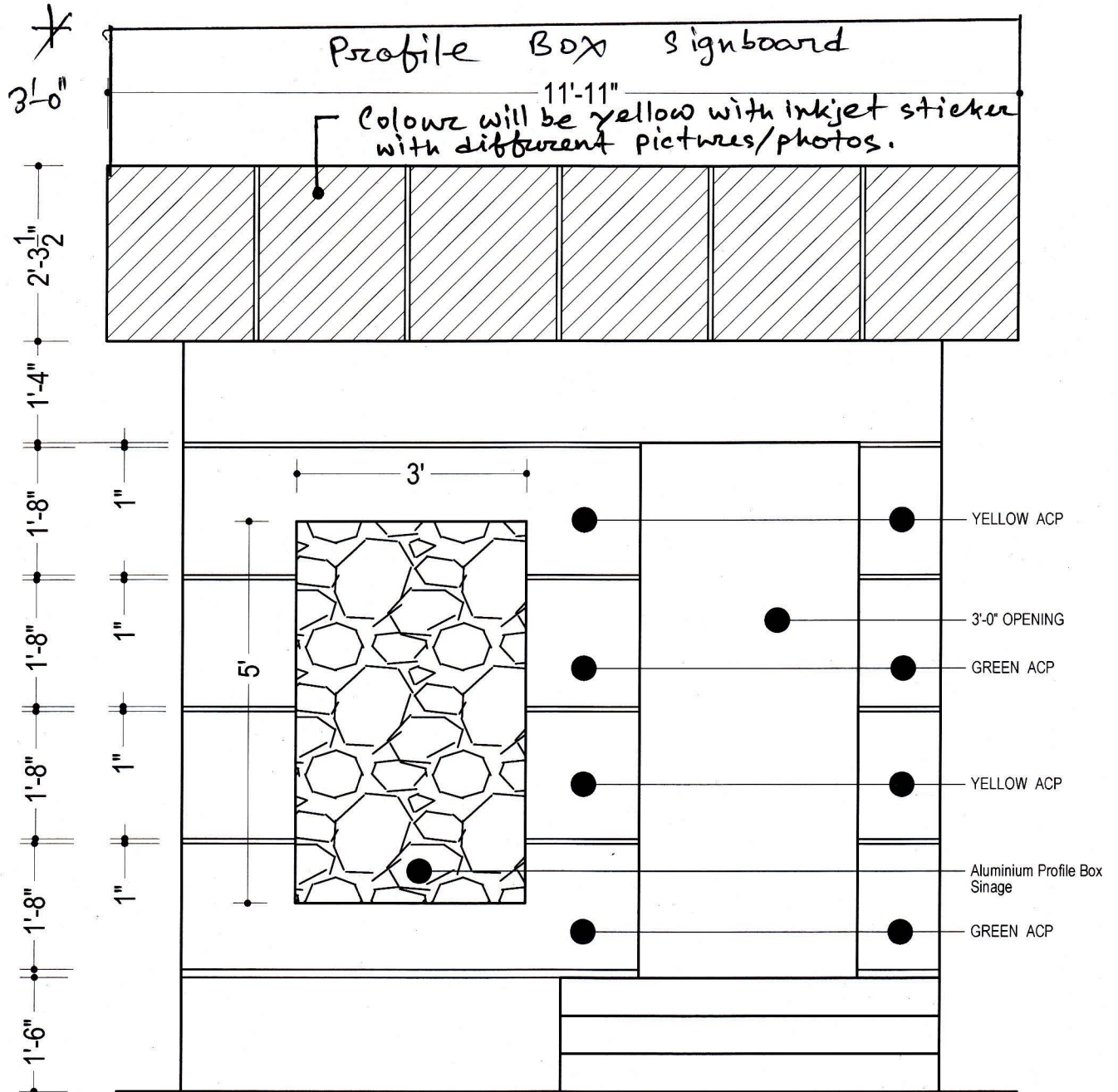

FRONT ELEVATION WITH ALUMINIUM COMPOSITE PANNEL.

ATM BOOTHS LAYOUT FOR INTERIOR & BRANDING ON CASE TO CASE BASIS.
FOR OUR CARD DIVISION, PUBALI BANK LIMITED, HEAD OFFICE, DHAKA.
A-A BHABAN, 23, MOTIJHEEL COMMERCIAL AREA, 2ND FLOOR, DHAKA.

Proposed Layout &
Other Design Prepared by

A.S.M. Sayem
A.S.M. Sayem
Sr. Pr. Officer-Engineering (Architect)
Pubali Bank Limited
GS & DD, H.O
Dhaka-1000.

Description of Design/Layout

FRONT Elevation.

Date of Design/Layout

25/01/2017

Sheet No. of Design/Layout

08 (Eight)



পুবালী ব্যাংক লিমিটেড
সাধারণ সেবা ও উন্নয়ন বিভাগ
প্রধান কার্যালয়, ঢাকা।

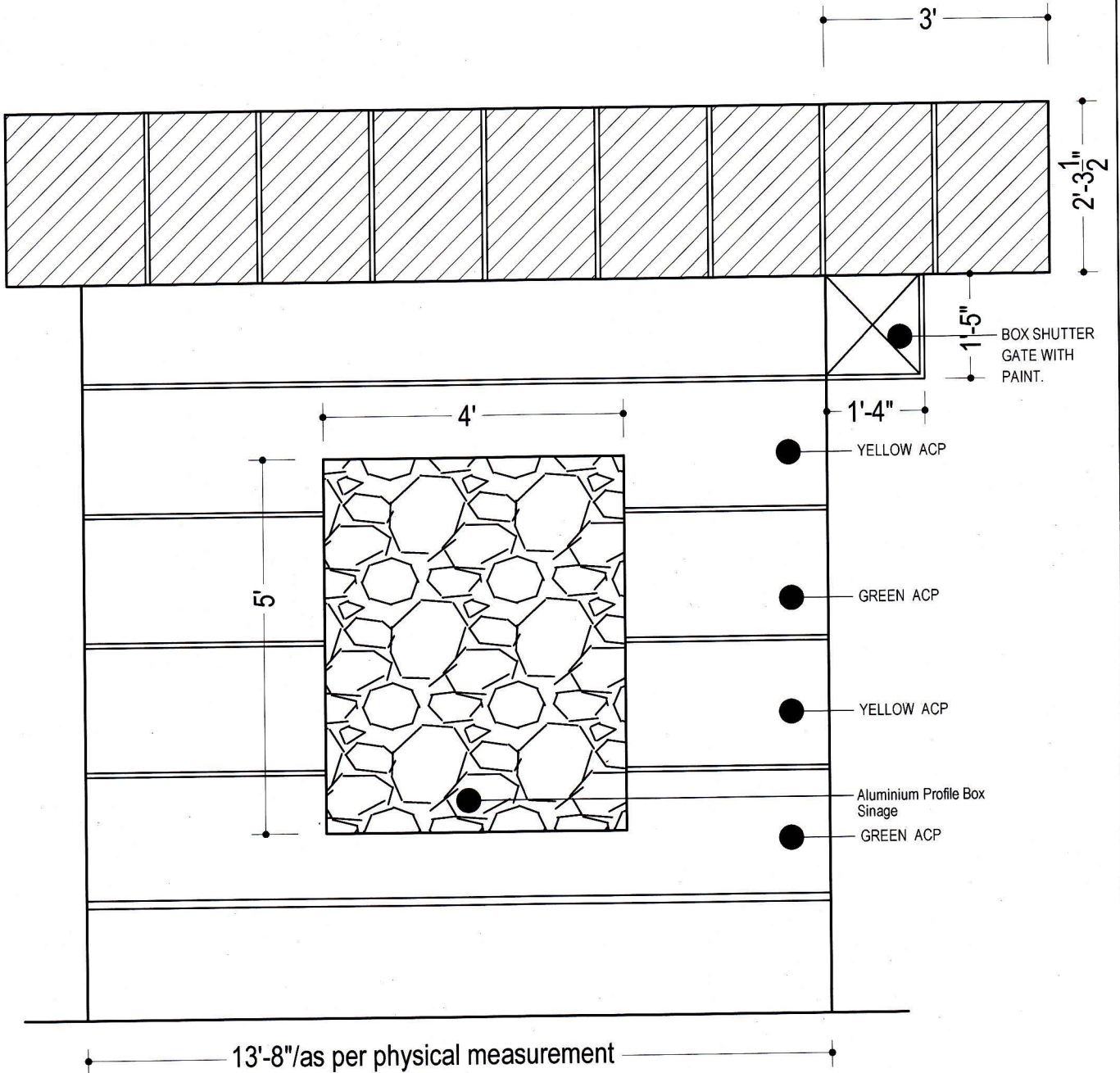

ELEVATION WITH ALUMINIUM COMPOSITE PANNEL.

ATM BOOTHS LAYOUT FOR INTERIOR & BRANDING ON CASE TO CASE BASIS.
FOR OUR CARD DIVISION, PUBALI BANK LIMITED, HEAD OFFICE, DHAKA.
A-A BHABAN, 23, MOTIJHEEL COMMERCIAL AREA, 2ND FLOOR, DHAKA.

Proposed Layout &
Other Design Prepared By

(Signature)
A.S.M. Sayeem
Sr. Pr. Officer-Engineering (Architect)
Pubali Bank Limited
GS & DD, H.O
Dhaka-1000.

Description of Design/Layout
Left or Right Side Elevation.

Date of Design/Layout

25/01/2017

Sheet No. of Design/Layout

09 (Nine)



পূবালী ব্যাংক লিমিটেড
সাধারণ সেবা ও উন্নয়ন বিভাগ
প্রধান কার্যালয়, ঢাকা।

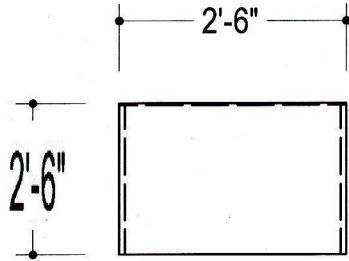

Top View Of Cabinet

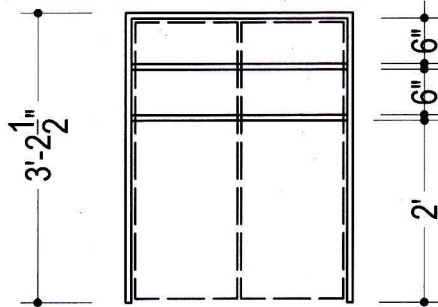

Front Elevation Of Cabinet

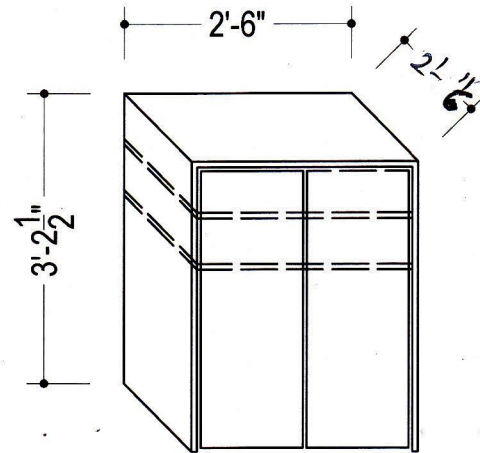

Isometric View of Cabinet

ATM BOOTHS LAYOUT FOR INTERIOR & BRANDING ON CASE TO CASE BASIS.
FOR OUR CARD DIVISION, PUBALI BANK LIMITED, HEAD OFFICE, DHAKA.
A-A BHABAN, 23, MOTIJHEEL COMMERCIAL AREA, 2ND FLOOR, DHAKA.



Proposed Layout &
Other Design Prepared By

A.S.M. Sayeen
A.S.M. Sayeen
Sr. Proj. Officer-Engineering (Architect)
Pubali Bank Limited
GS & DD, H.O
Dhaka-1000.

Description of Design/Layout

Melamine Board Cabinet Detailed.

Date of Design/Layout

25/01/2017

Sheet No. of Design/Layout

10 (Ten)

DESCRIPTION OF WORKS:-

01. NEW 1'-0" X 1'-0" SIZE HOMOGENEOUS TILES WORKS WILL BE DONE FOR FLOOR FINISHING.
02. ALUMINIUM COMPOSITE PANNEL WORKS WILL BE DONE FOR WALLS & CANOPY.
03. ALUMINIUM PROFILE BOX SIGNAGE WILL BE DONE IN DIFFERENT WALLS ALSO WITH TOP OF CANOPY.
04. FROSTED/COLOUR INKJET STICKER PAPER WORKS WILL BE DONE FOR GLASS & ACP OF CANOPY.
05. 10mm THICK TEMPERED GLASS SWING DOOR WILL BE DONE.
06. 10mm THICK NON-TEMPERED GLASS PARTITIONS WORKS WILL BE DONE.
07. NEW METAL BOARD FALSE CEILING WILL BE DONE AS PER LAYOUT WITH LED PANNEL LIGHT.
08. NEW ROAD SIDE SIGNAGE WILL BE DONE BY ALUMINIUM DIFFERENT SIZES PROFILE BOX (BOTH SIDE PANAFLEX SHEET).
09. NEW MELAMINE BOARD SMALL CABINET WILL BE DONE AS PER DESIGN.
10. INSIDE & OUTSIDE (IF NEEDED) DIFFERENT WALLS WILL BE PLASTIC PAINT/Weather coat.
11. STICKER ON PVC BOARD IN INNER SIDE WALLS WITH SCREWS.
12. LED PANNEL LIGHT WORKS WILL BE DONE.
13. NECESSAR DISMANTLING WORKS WILL BE DONE (IF NEEDED).
14. NEW M.S. BOX SHUTTER WORKS WILL BE DONE WITH PROPER PAINT.
15. NEW REQUIRED 10" THICK FIRST CLASS BRICK WORKS WILL BE DONE WITH BOTH SIDE 1/2" THICK PLASTER (IF NEEDED).
16. NEW REQUIRED 5" THICK FIRST CLASS BRICK WORKS WILL BE DONE WITH BOTH SIDE 1/2" THICK PLASTER (IF NEEDED).
17. NEW 3" THICK FLAT BRICK SOILING WILL BE DONE (IF NEEDED).
18. NEW 3" THICK CEMENT CONCRETE WORKS WILL BE DONE AT FLOOR (IF NEEDED).
19. NEW 5" THICK REINFORCEMENT CEMENT CONCRETE WILL BE DONE FOR SLAB WITH BOTTOM FINISHED BY 1/2" THICK PLASTER. (IF NEEDED).

N.B.: (1) ALL KINDS (15 TO 19) OF CIVIL CONSTRUCTION WORKS WILL BE DONE WHERE NECESSARY (CASE TO CASE BASIS).
(BY THE LOCAL AUTHORITY i.e. CONCERNED BRANCH MANAGER'S & RM).

(2) ALL KINDS OF MATERIALS QUALITY & COLOUR WITH SAMPLE DESIGN WILL BE APPROVED THE CARD DIVISION.

ATM BOOTHS LAYOUT FOR INTERIOR & BRANDING ON CASE TO CASE BASIS.
FOR OUR CARD DIVISION, PUBALI BANK LIMITED, HEAD OFFICE, DHAKA.
A-A BHABAN, 23, MOTIJHEEL COMMERCIAL AREA, 2ND FLOOR, DHAKA.



Proposed Layout &
Other Design Prepared By

A.S.M. Sayem
A.S.M. Sayem
Sr. Pr. Officer-Engineering (Architect)
Pubali Bank Limited
GS & DD, H.O
Dhaka-1000.

Description of Works:

Detailed Description Of Works.

Date of Design/Layout

Sheet No. of Design/Layout

25/01/2017

11 (Eleven).